

# Krossing / Krossing

Il sistema Krossing è composto da piani e tubetti in alluminio anodizzato o verniciato bianco e nero, è studiato per contenere un gran numero di libri (ma anche cd, dvd, bottiglie, etc.) con un ingombro minimo: 15 cm. Si possono comporre forme regolari (quadrati e/o rettangoli) da una larghezza minima di 34 cm ad una massima di 200 cm oppure si possono disegnare forme creative, lettere dell'alfabeto, sempre larghezza minima 34 fino larghezza e altezza infinita. E' possibile richiedere misure o RAL Speciali.

The Krossing system is composed by shelves and tubes in anodized aluminum or painted white and black, is designed to accommodate a large number of books (but also CDs, DVDs, bottles, etc..) in a small space: 15 cm. You can compose regular shapes (squares and / or rectangles) from a minimum width of 34 cm to a maximum of 200 cm, or you can draw creative forms, letters of the alphabet, always minimum width 34 to width and infinite height. Customized measurements or special RAL can be required.

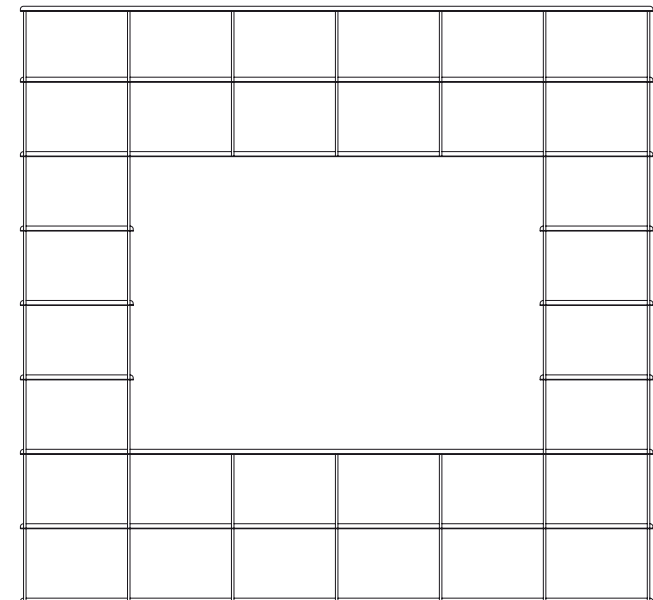

## FINITURE / FINISHINGS

-  Alluminio anodizzato / Anodized aluminium
-  Bianco Opaco RAL 9010 / Mat white RAL 9010
-  Nero opaco RAL 9005 / Mat black RAL 9005
-  Bianco lucido RAL 9010 / White bright RAL 9010
-  Nero semilucido RAL 9005 / Semi gloss black RAL 9005

## PIANETTI / SHELVES

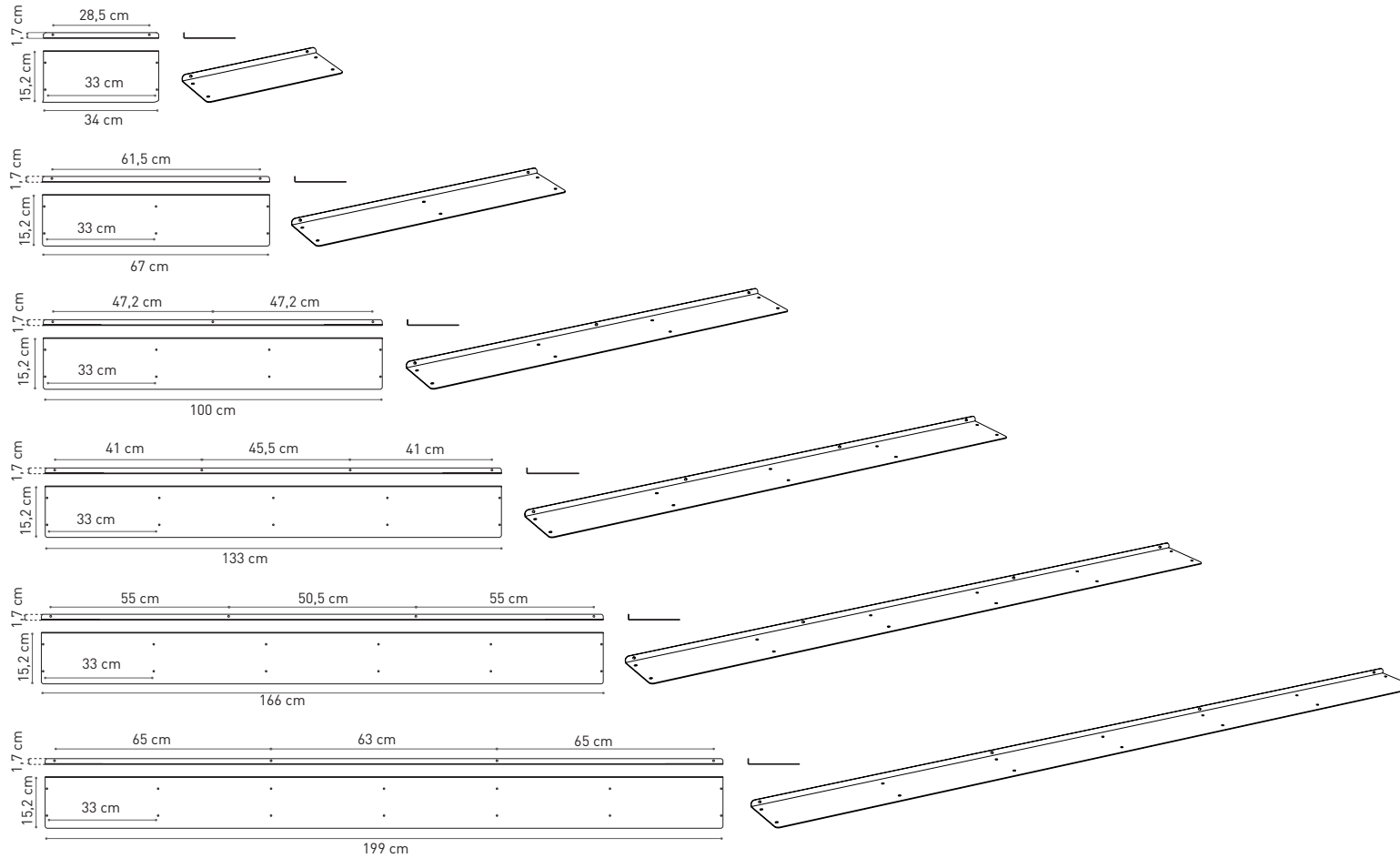

## PIANI PORTA BICCHIERI / GLASS HOLDER SHELVES

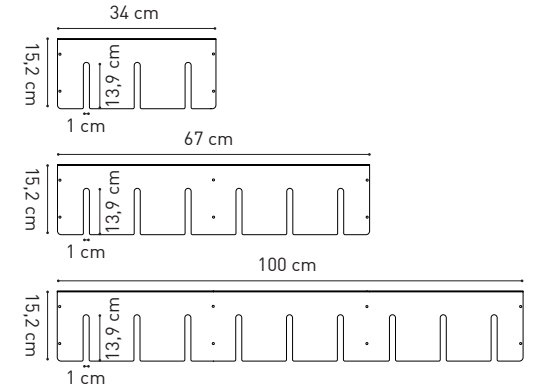

## BOX

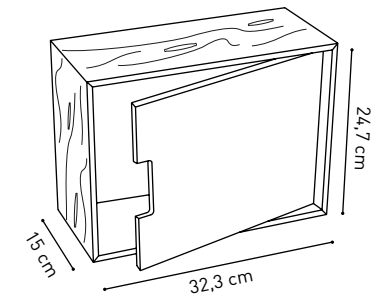

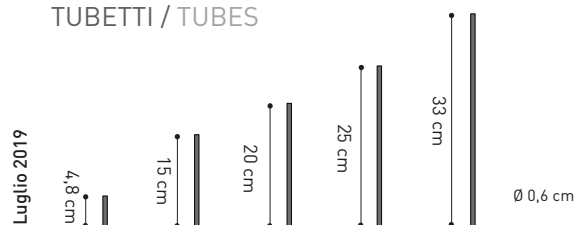

## TUBETTI / TUBES



- 4,8 cm → da abbinare a ripiano fresato porta bicchieri - to match with shelf for glasses
- 15 cm → CDs - Bicchieri / Glasses
- 20 cm → DVDs
- 25 cm → Libri / Books
- 33 cm → Bottiglie / Bottles

## FINITURE / FINISHINGS

-  Rovere melaminico / Melamine oak
-  Bianco Opaco RAL 9010 / Mat White RAL 9010

## CAPACITA' / CAPACITY:

32 CDs

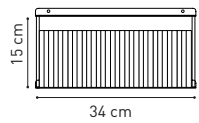

22 DVDs

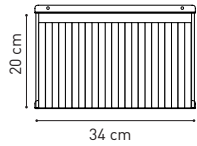

16 Libri\* / Books\*

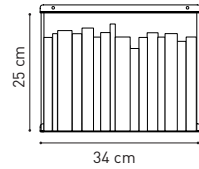

\*Libri di circa 200 pag.  
\*Books of 200 pages

3 Bottiglie / Bottles

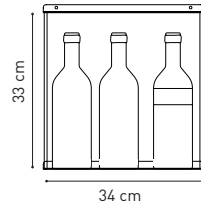

## PORTATA / LOAD CAPACITY:

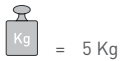

= 5 Kg

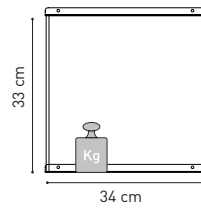
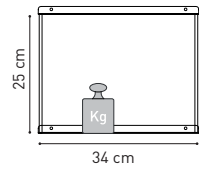
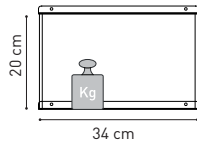
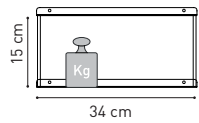

## ISPIRAZIONI / INSPIRATION:

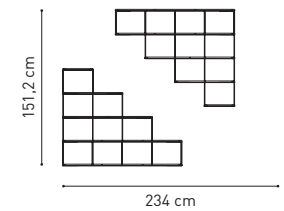
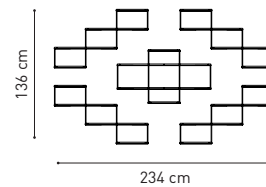
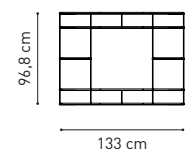
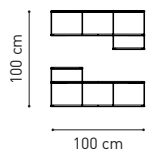
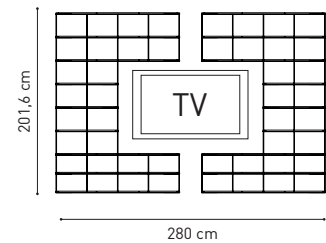
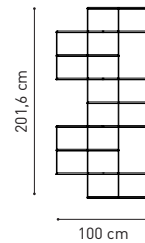
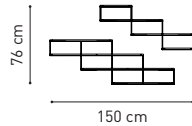
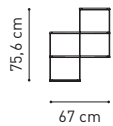

## INGOMBRO / OVERALL DIMENSIONS:

Esempio calcolo ingombro totale / How to calculate the total overall

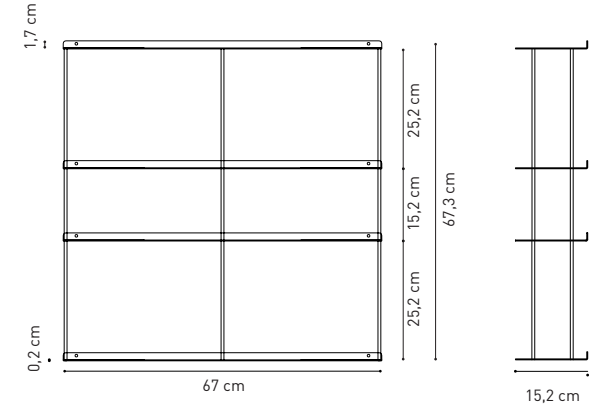

# Guida alla manutenzione / Maintenance guide

## COMPONENTI IN ALLUMINIO

Manutenzione ordinaria con detergente per piatti e un panno umido.

Sono severamente vietati prodotti a base di acetone, aceto o ammoniacca, spugne abrasive e prodotti a base di creme abrasive o particolarmente aggressivi.

## ALUMINIUM COMPONENTS

Ordinary service with dish detergents and a wet cloth.

Acetone, vinegar or ammonia based and particularly aggressive products are strictly forbidden, as much as abrasive sponges or lotions.

## COMPONENTI IN LEGNO

Il legno è un materiale vivo, caratterizzato da variazioni naturali a livello di tonalità e struttura, quindi l'incidenza della luce e dei raggi solari comportano normali variazioni di colore. Le superfici sono sigillate da una vernice di alta qualità, è vivamente sconsigliato sottoporre il legno ad aria troppo umida o troppo secca. In caso contrario, il legno si deforma malgrado la vernice applicate. Per la pulizia ordinaria è sufficiente una passata con un panno morbido o al massimo con un panno leggermente umido. L'utilizzo di prodotti abrasivi per la pulizia (panni in microfibra, spugne per lucidare ecc...) rischia di graffiare le superfici. Le macchie di prodotti alimentari di origine animale grassa o vegetale, bevande e altri liquidi acidi possono compromettere definitivamente la superficie.

## WOODEN COMPONENTS

Being an alive material, wood is characterized by natural variations of hue and structure, artificial or sun lights can cause colour variations. Surfaces are protected by a high quality coating: don't expose wood to either too wet or too dry air or it will deform despite the applied paint. A soft cloth, dry or a bit humid, is sufficient for ordinary cleanings. The use of abrasive products (microfiber cloths, polishing sponges, ...) is not recommended as they might scratch the surfaces. Stains from vegetal and animal food, or from drinks and other acid liquids, might compromise the surfaces.

